



USER MANUAL

# OasisMist™ Smart Humidifier

Model: LUH-O451S-WUS



## Questions or Concerns?

Please contact us Mon–Fri, 9:00 am–5:00 pm PST/PDT at [support@levoit.com](mailto:support@levoit.com) or at **(888) 726-8520**.

## Table of Contents

Package Contents	2
Specifications	2
Safety Information	3
Getting to Know Your Smart Humidifier	5
Controls	7
Getting Started	8
VeSync App Setup	10
Using Your Smart Humidifier	11
Care & Maintenance	15
Troubleshooting	20
VeSync App Troubleshooting	23
Warranty Information	25
Customer Support	26

## Package Contents

1 × Smart Humidifier
1 × Cleaning Brush
3 × Aroma Pad (1 Pre-Installed)
3 × Absorption Pad (1 Pre-Installed)
2 × Water Filter Sponge (1 Pre-Installed)
1 × User Manual
1 × Quick Start Guide

## Specifications

<b>Power Supply</b>	AC 120V, 60Hz
<b>Rated Power</b>	280W
<b>Water Tank Capacity</b>	1.19 gal / 4.5 L
<b>Max Cool Mist Output</b>	300 mL/h
<b>Max Warm Mist Output</b>	550 mL/h
<b>Max Runtime</b>	45 hours on low mist setting <b>Note:</b> The humidifier may run for a longer or shorter time depending on the environmental temperature and humidity.
<b>Noise Level</b>	Lowest: < 26dB (Low Cool Mist) Highest: < 41dB (High Warm Mist)
<b>Effective Range</b>	215–430 ft <sup>2</sup> / 20–40 m <sup>2</sup>
<b>Dimensions</b>	10.8 x 6.0 x 11.97 in / 27.4 x 15.2 x 30.4 cm
<b>Weight</b>	5.3 lb / 2.4 kg

**Note:** To access additional smart humidifier functions, download the free VeSync app (see page 10).

# READ AND SAVE THESE INSTRUCTIONS

## SAFETY INFORMATION

To reduce the risk of fire, electric shock, or other injury, follow all instructions and safety guidelines.

### General Safety

- **Only** use the humidifier as described in this manual.
- Place the humidifier and cord so that it will not be knocked over. **Do not** place near large pieces of furniture or in high-traffic areas.
- When not in use, turn the humidifier off and disconnect from power by removing the plug from the outlet.
- **Do not** use the humidifier in wet environments.
- Keep the humidifier out of reach from children.
- **Do not** open the base or remove the water level sensor for self-servicing.
- **Always** unplug your humidifier from the power outlet before cleaning your humidifier or detaching the water tank from the humidifier base.
- **Always** make sure to place the humidifier on a flat, level surface before operation.
- **Only** fill the water tank with clean water. **Never** fill the water tank with any other liquids.
- **Do not** place the humidifier near sources of heat, such as stovetops, ovens, or radiators.
- **Do not** place the humidifier directly on floors, carpets, or rugs.
- **Do not** use other items as replacement parts for this product.
- **Do not** cover the nozzles while the humidifier is on. Doing so may damage the humidifier.
- Remove the water tank from the base before moving the humidifier.
- **Do not** immerse the humidifier base, power cord, or plug in water.
- **Do not** clean the humidifier immediately after turning it off, especially if it has been diffusing warm mist. Allow the humidifier to cool down completely before cleaning.
- If the humidifier is damaged or is not functioning properly, stop using it and contact **Customer Support** immediately (see page 26).
- This humidifier is not to be used by persons (including children) with reduced physical, sensory, or mental capabilities, or lack of experience and knowledge, unless they have been given supervision or instruction concerning use of the appliance by a person responsible for their safety.
- Supervise children when they are near the humidifier.
- Children should not clean or perform maintenance on the humidifier without supervision.
- Children should be supervised to ensure that they **do not** play with the humidifier.
- Not for commercial use. Household use **only**.

## SAFETY INFORMATION (CONT.)

### Power & Cord

- Ensure that the plug fits properly into a polarized socket.
- Your humidifier has a polarized plug (one prong is wider than the other), which fits into a polarized outlet only one way. This is a safety feature to reduce the risk of electric shock. If the plug does not fit, reverse the plug. If it still does not fit, **do not** use the plug in that outlet. **Do not** bypass this safety feature.
- **Do not** handle the power cord or plug with wet hands. Keep the plug and power cord away from liquids.
- If the power supply cord is damaged, it must be replaced by Arovast Corporation or similarly qualified persons in order to avoid an electric or fire hazard. Please contact **Customer Support** (see page 26).
- Unplugging the power cord will disable remote control of the humidifier and temporarily disconnect the humidifier from VeSync and other third-party apps.

### Caution: Risk of Leaks and Electric Shock

- **Only** add essential oils to the aroma pad.
- **Do not** add essential oils, supplemental water treatment liquids, or water filters into the water tank or base chamber. This will damage the humidifier and cause leaks.

### Caution: HOT Water Vapor

- Let nozzles and mist tube cool before touching or cleaning.

### Electromagnetic Fields (EMF)

This humidifier complies with all standards regarding electromagnetic fields (EMF). If handled properly and according to the instructions in this user manual, the appliance is safe to use based on scientific evidence available today.

# GETTING TO KNOW YOUR SMART HUMIDIFIER

- A.** Top Cover
- B.** Nozzles
- C.** Handle
- D.** Water Tank
- E.** Mist Tube
- F.** LED Display
- G.** Control Panel
- H.** Base
- I.** Water Filter
- J.** Water Filter Sponge
- K.** Heating Element
- L.** Float
- M.** Transducer
- N.** Float Brackets
- O.** Power Cord
- P.** Noise Silencer
- Q.** Absorption Pad
- R.** Air Outlet
- S.** Aroma Pad
- T.** Aroma Box
- U.** Humidity Sensor / Air Inlet (In Aroma Box Compartment)
- V.** Air Inlet (Under the Base)
- W.** Cleaning Brush
- X.** Feet
- Y.** Mist Channel (Under Water Tank)

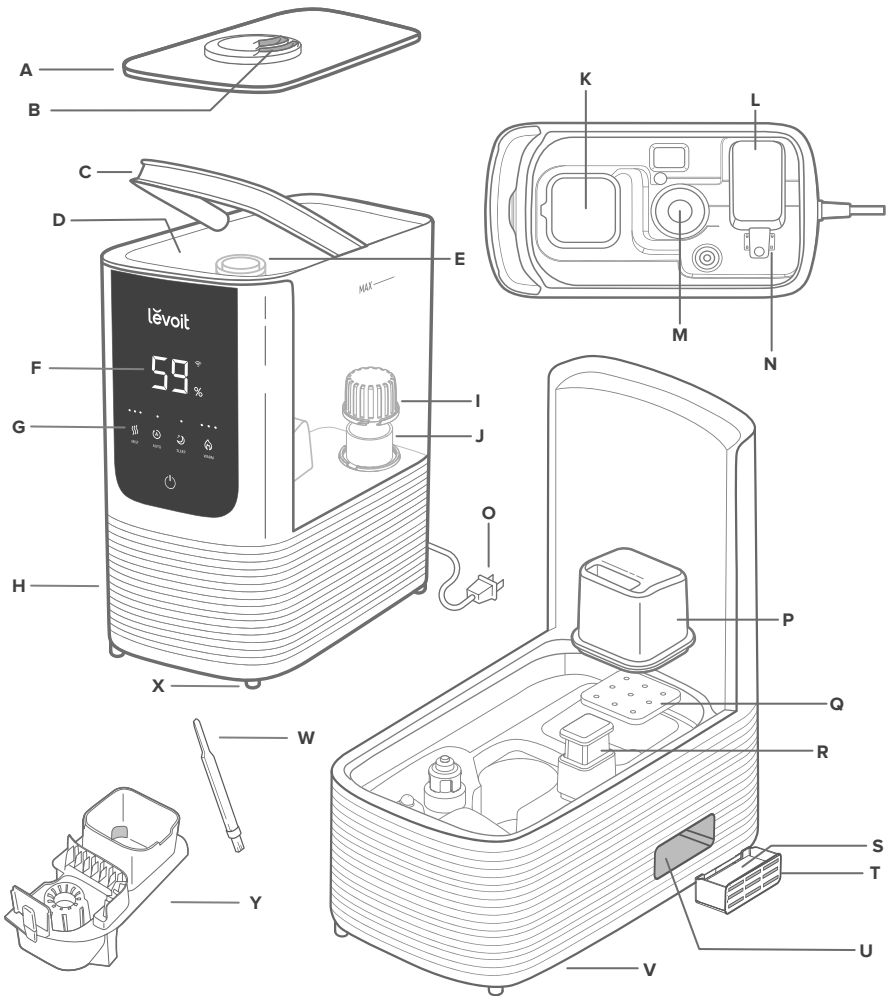

GETTING TO KNOW YOUR SMART HUMIDIFIER (CONT.)

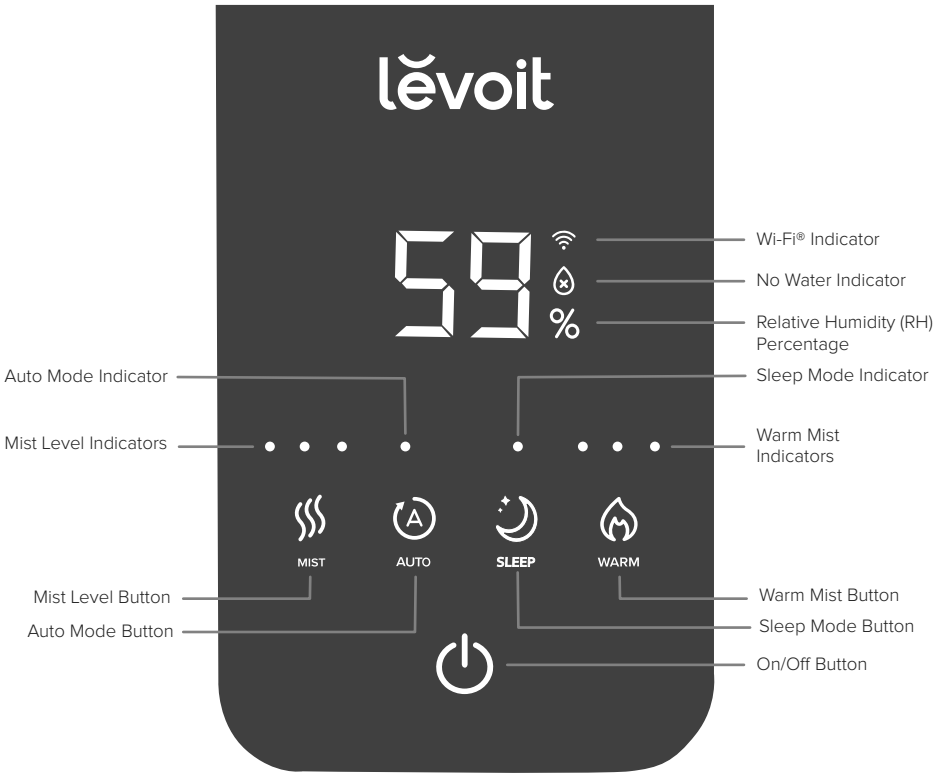

**Mist Level Indicators (White)**

- ● ● Low Mist
- ● ● Medium Mist
- ● ● High Mist

**Warm Mist Indicators (Orange)**

- ● ● Heat Off
- ● ● Low Heat
- ● ● Medium Heat
- ● ● High Heat

# CONTROLS

**Note:** You can also use the VeSync app to control these functions, as well as additional app-only features (see page 10).



## On/Off Button

- Press to turn the humidifier on/off.
- Press and hold for 5 seconds to pair with the VeSync app. See the in-app instructions for more information.
- Press and hold for 15 seconds to reset the humidifier. This will restore the humidifier's default settings and disconnect it from Wi-Fi® and the VeSync app (see page 10).







## Mist Level Button

- Press repeatedly to cycle through mist level settings: low, medium, and high mist.
- Press and hold for 3 seconds to turn the display off. Press any button to turn the display back on.



## Auto Mode Button

- Press to turn Auto Mode on (see page 12).
- Press  to use warm mist while in Auto Mode.
- Press  /  /  to turn Auto Mode off and resume manual controls.



## Warm Mist Button

- Cycles through warm mist settings: low heat, medium heat, high heat, and heat off (see page 11).



## Sleep Mode Button

- Press to turn Sleep Mode on/off (see page 12).



## Wi-Fi Indicator

- Turns on, off, or blinks to indicate pairing status. See the VeSync in-app instructions for more information.



## No Water Indicator

- Blinks when there is no water in the tank. After this indicator blinks 10 times, the humidifier will turn off. Refill the tank and properly place it on the base to use your humidifier.
- Lights up when the water tank is removed. Remains on until the tank is replaced.

# GETTING STARTED

1. Remove all packaging.
2. Clean the water tank and water tank cover before first use.

**Note:** Check to make sure that the water filter is correctly in place. If not, then rotate the filter clockwise to secure it in place. [Figure 1.1]

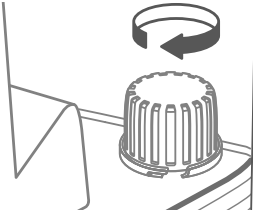

Figure 1.1

3. Choose a hard, flat location for the humidifier at least 12 inches / 30 cm away from any walls. The surface must be water-resistant. [Figure 1.2]

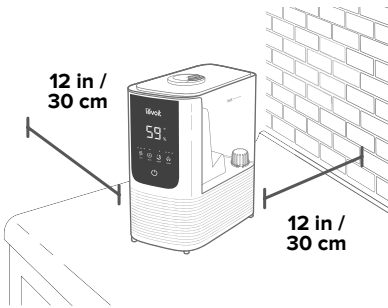

Figure 1.2

**Note:**

- **Do not** place the humidifier directly on floors, carpets, or rugs.
- Placing the humidifier away from walls ensures that the humidity sensor and air inlets function properly.

4. Mist should be directed away from walls, furniture, bedding, and appliances. [Figure 1.3] Avoid letting too much mist fall on the side of the humidifier with the aroma box, as this may interfere with the sensor inside the aroma box.

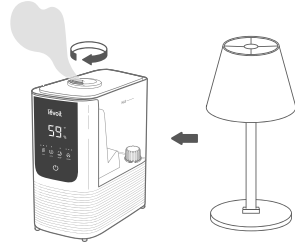

Figure 1.3

## Filling & Refilling

**Note:** Make sure the water tank is clean before filling.

1. Remove the water tank cover. [Figure 1.4]

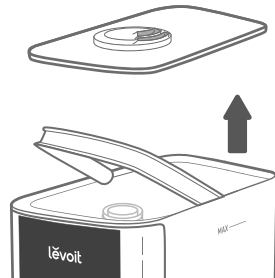

Figure 1.4



- Use the handle to remove the tank from the base. Fill the tank with room-temperature water. *[Figure 1.5]* **Do not** fill with hot water.

**Note:**

- We recommend using purified or distilled water to fill the tank.*
- Using tap water may result in a white dust (dried minerals) on surfaces*



Figure 1.5

- Replace the water tank cover and place the tank back on the base.

## CAUTION

- Do not** add water directly into the base chamber. *[Figure 1.7]*

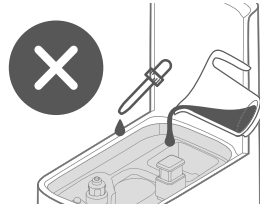

Figure 1.4

- Do not** add water through the mist tube.
- Do not** add essential oils into the humidifier. **Only** add essential oils to the aroma pad. *[Figure 1.5]*

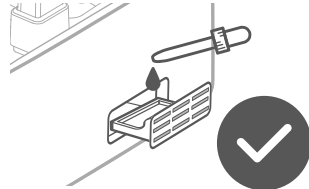

Figure 1.5

- Do not** use water treatment liquids or third-party water filters in this humidifier.

# VESYNC APP SETUP

**Note:** Due to ongoing updates and improvements, the VeSync app may be slightly different than shown in the manual. In case of any differences, follow the in-app instructions.

1. To download the VeSync app, scan the QR code or search “VeSync” in the Apple App Store® or Google Play Store. [Figure 2.1]



Figure 2.1

2. Open the VeSync app. If you already have an account, tap Log In. To create a new account, tap **Sign Up**.

**Note:** You must create your own VeSync account to use third-party services and products. These will not work with a guest account. With a VeSync account, you can also allow your family and friends to control your smart humidifier.

3. Follow the in-app instructions to set up your smart humidifier.

**Note:**

- You can use the VeSync app to connect your smart humidifier to Amazon Alexa or Google Assistant™. Follow the in-app instructions to connect VeSync to your voice assistant.
- Your phone must have Location turned on while your phone is connecting to your smart humidifier. This is required to establish the Bluetooth® connection. You can turn Location off after your smart humidifier is finished connecting to the VeSync app.

## Wi-Fi Connection

- To disconnect Wi-Fi, press and hold  for 15 seconds until the Wi-Fi indicator turns off. This will restore the smart humidifier's default settings and disconnect it from the VeSync app.
- To reconnect, please follow the instructions in the VeSync app for adding a device.

# USING YOUR SMART HUMIDIFIER

**Note:** Using the VeSync app allows you to control your smart humidifier remotely and access additional functions and features (see page 10).

1. Plug in the humidifier. The indicators on the display will light up for 1 second, then turn off.
2. Press  to turn your humidifier on. The humidifier will start misting.

**Note:** If there is no water in the tank,  will flash 10 times, and the humidifier will turn off. Fill the water tank (see **Getting Started**, page 8).

3. Press  repeatedly to cycle through mist settings: Low, Medium, and High. [Figure 3.1]

- ● ● Low Mist
- ● ● Medium Mist
- ● ● High Mist

Figure 3.1

4. Rotate the nozzles to adjust the direction of the mist. [Figure 3.2]

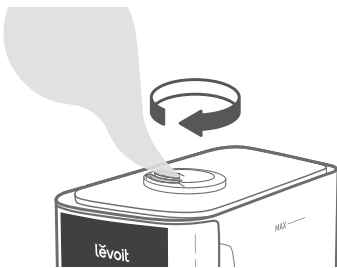

Figure 3.2

**Note:**

- Direct the nozzles away from any furniture, walls, or other objects to prevent them from getting wet.
- **Do not** inhale the mist directly from the nozzles.

5. Optionally, use the controls or the VeSync app to turn on warm mist, activate Sleep Mode, and more (see **Controls**, page 7).
6. When your room has reached your preferred humidity level, turn the humidifier to a lower setting, or turn it off. A comfortable humidity level is between 40% and 60%.

**Note:** You can also set the humidifier to automatically stop misting when the room reaches a specific humidity level (see **Auto Mode**, page 12).

7. Press  to turn your humidifier off.

## Warm Mist

- Press  to turn on warm mist. Keep pressing to increase the heat setting of the mist, and to turn warm mist off. [Figure 3.3]

- ● ● Heat Off
- ● ● Low Heat
- ● ● Medium Heat
- ● ● High Heat

Figure 3.3

- The humidifier may take 15 minutes to warm up before producing warm mist.
- **Caution:** Mist may be hot. **Do not** place your bare hands, face, or other exposed skin over the nozzles while using warm mist. [Figure 3.4] Nozzles can reach temperatures as high as 140°F / 60°C.



Figure 3.4

## Warm Mist (cont.)

Warm Mist Setting	Nozzle Temperature (+/- 5%)
Low Heat	104°F / 40°C
Medium Heat	122°F / 50°C
High Heat	140°F / 60°C

## Auto Mode

Auto Mode uses the humidifier's sensor to automatically adjust the mist level to maintain a target humidity level. The default target humidity level is 60%.

**Note:** You can use the VeSync app to change the target humidity level to fit your needs.

1. Press  to turn Auto Mode on.

**Note:** The humidifier will automatically mist for 15 seconds after being turned on, even if the room has reached the target humidity level.

2. Optionally, press  to turn on warm mist and adjust the warm mist setting.
3. By default, Auto Mode uses Automatic Stop. The humidifier will stop misting when the highest target humidity level is reached (default 60%).

**Note:**

- In the VeSync app, you can turn Automatic Stop on/off.
- If Automatic Stop is off, the humidifier will keep running on low mist level when the highest target humidity level is reached.

4. The humidifier will continue detecting the humidity level in the room. It will start and stop misting again according to the following table:

Room Relative Humidity *	Automatic Mist Level
Under 50%	High
50–55%	Medium
55–60%	Low
Over 60%	Automatic Stop

\*If you change the target humidity from 60% in the VeSync app, the humidity percentages will change accordingly.

## Sleep Mode

Sleep Mode changes the humidifier's mist setting to low and turns off the display lights, making it ideal for sleep. Sleep Mode can **only** be used with cool mist.

- Press  to turn Sleep Mode on/off.

**Note:** Sleep Mode automatically turns off warm mist to reduce noise levels.

- When Sleep Mode is on, you can press any button to wake up the display. If you stop touching the display, the display will turn off again after 6 seconds.
- Once you wake up the display, press any button to exit Sleep Mode and resume manual controls.

## Turning Off the Display

The display will automatically dim after 3 seconds of inactivity.

- To turn off the display, press and hold  for 3 seconds.
- To turn the display back on, press any button.

## Using the Aroma Box

Your humidifier can be used for aromatherapy.

1. Push the aroma box at the back of the base and pull it out. [Figure 4.1]

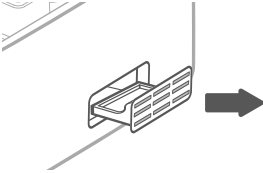

Figure 4.1

2. Put 8–10 drops of essential oils on the aroma pad. [Figure 4.2]

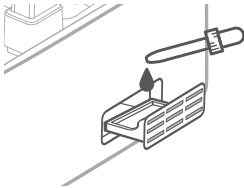

Figure 4.2

3. Insert the aroma box back into the humidifier.
4. Turn on the humidifier. The humidifier will automatically diffuse aroma when used.

### Note:

- **Do not** add essential oils, water treatment liquids, or third-party water filters into the water tank or base chamber. **Only** add essential oils to the aroma pad. [Figure 4.3]

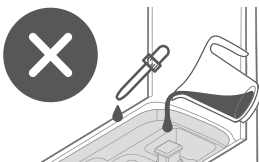
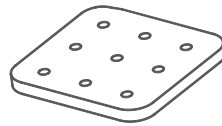

Figure 4.3

- The aroma pads can be cleaned and reused after diffusing essential oils (see **Cleaning the Aroma Pad & Absorption Pad**, page 18).
- This humidifier uses a small heat-based aroma diffuser. The aroma is intended to be light.
- For information on replacement aroma pads, see page 18.

## Absorption Pads



The mineral absorption pads help reduce mineral buildup (scale) inside the humidifier, especially on the heating element.

**Note:** For information on replacement absorption pads, see page 18.

## Memory Function

- The humidifier will remember your settings for Mist Level, Warm Mist, and Wi-Fi settings when turned off or unplugged, and will resume those settings when turned back on.
- The humidifier will remember Sleep Mode or Auto Mode settings, and the display will automatically turn back on when the humidifier is turned back on.

## Automatic Shutoff

The humidifier will automatically turn off when all of the water in the tank has been diffused.  will show on the display and blink 10 times before the humidifier turns off. Fill the water tank (see **Getting Started**, page 8).

If the tank has been removed from the base, the humidifier will automatically stop misting.  will show on the display and will turn off once the tank is placed properly back on the base.

## VeSync App Functions

The VeSync app allows you to access additional smart functions, including those listed below.

### Remote Control From Your Phone

- Turn the humidifier on/off.
- Cycle through mist levels and heat levels.
- Turn Auto Mode on/off and set target humidity level.
- Turn Sleep Mode on/off.
- Turn the display lights on/off.

### Monitor Humidity Levels

- Check current humidity levels in the humidifier's environment.

### Set Timers & Schedules

- Program individual timers or create a schedule for your smart humidifier.

### Third-Party Voice Control

- Compatible with Amazon Alexa and Google Assistant™ for voice commands.

**Note:** The VeSync app is continually updated and app features will expand.

## Important Tips

Your humidifier must have the correct level of water in the base chamber to work properly. If there is too much water in the base chamber, the humidifier cannot create mist.

- **Do not** place the humidifier on an inclined surface.
- **Never** pour water directly into the base chamber. **[Figure 5.1]** Only add water to the water tank. The humidifier will automatically release the correct amount of water into the base chamber.

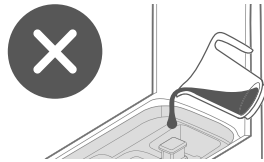

Figure 5.1

- Avoid moving or shaking the humidifier. **[Figure 5.2]** This may cause the water tank to release too much water into the base chamber.



Figure 5.2

- Before moving the humidifier, turn it off, unplug it, and remove the water tank. Empty any excess water from the base chamber.

# CARE & MAINTENANCE

**Note:**

- All maintenance should be done on a water-resistant surface, such as a kitchen counter.
- Change the water daily to avoid bacteria growth.
- Use a tissue or cloth to clean the nozzles regularly.
- If not using the humidifier for 1 week or longer, **do not** leave water inside. Clean and dry the humidifier instead.

## Cleaning

You should clean your humidifier water tank and base chamber every 3 days, and when you're ready to store it.

**Note:**

- **Never** immerse the base in water or liquid. **Do not** place any part of the humidifier in a dishwasher.
- **Do not** use detergents to clean the humidifier.

1. Unplug the humidifier.

**Note:** If you've been using the warm mist setting, allow the humidifier to cool before cleaning.

2. Remove and rinse the water tank cover. [Figure 6.1]

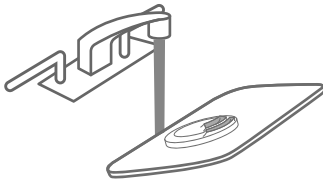

Figure 6.1

3. Remove the water tank from the base. Pour out any water from the tank and base chamber. If you've used the warm mist setting, **use caution** in case the water is still hot.

**Note:** When pouring out water, hold down the float to ensure that it does not fall out of the base chamber.

4. Remove the water filter from the tank by rotating it counterclockwise and lifting it out. [Figure 6.2]

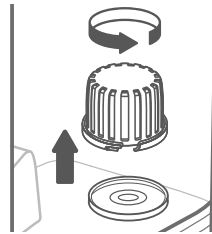

Figure 6.2

5. Remove the water filter sponge from the water filter if necessary for cleaning. [Figure 6.3]

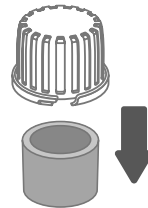

Figure 6.3

## Care and Maintenance (cont.)

6. Flip the water tank over. Pinch the tab and pull out the mist channel. [Figure 6.4]

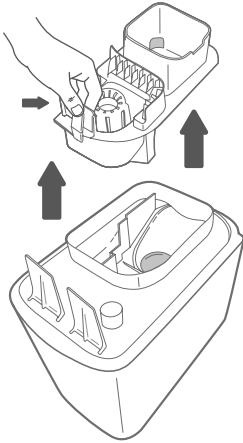

Figure 6.4

7. Remove the float, noise silencer, absorption pad, and aroma box from the base.
8. Rinse all parts (except the outside of the base) with room temperature water. [Figure 6.5]

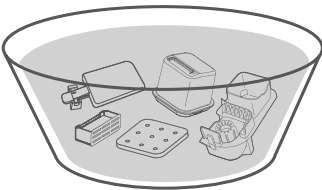

Figure 6.5

9. Dry all parts with a cloth. Make sure all parts are completely dry before reassembling or storing.

## Descaling Your Humidifier

To descale the humidifier (remove mineral buildup):

1. Remove the water filter and water filter sponge from the tank. Flip the tank over and remove the mist channel. Then, remove the noise silencer and absorption pad from the base.
2. Fill the tank with 3 US cups / 710 mL of distilled white vinegar. [Figure 7.1]

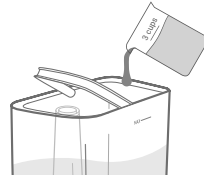

Figure 7.1

3. Replace the tank cover and swish the vinegar around the tank. [Figure 7.2]



Figure 7.2

4. Place the tank on the base and soak for 15–20 minutes. Vinegar will drain into the base chamber and loosen scale (mineral buildup) in the tank and in the base chamber (including the transducer and float). [Figure 7.3]



Figure 7.3



## Descaling Your Humidifier (cont.)

5. Remove the tank, remove the tank cover, and pour out any vinegar. [Figure 7.4]

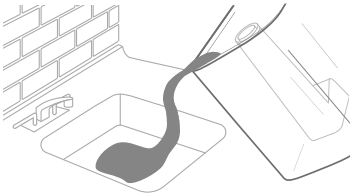

Figure 7.4

6. Remove the float from the base chamber by pulling up the larger side of the float and pulling the shaft out from the float brackets. One side of the float brackets is open (U-shaped) to allow the shaft to be removed. [Figure 7.5]

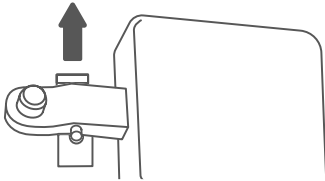

Figure 7.5

7. Place the float, water filter, mist channel, aroma box, and noise silencer in a container. Fill with enough vinegar to cover them. Soak for 15–20 minutes. [Figure 7.6]

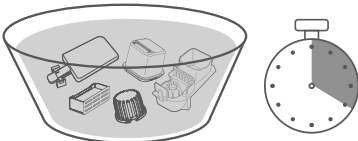

Figure 7.6

8. Use a soft cloth and the included cleaning brush to remove scale from all parts. [Figure 7.7]

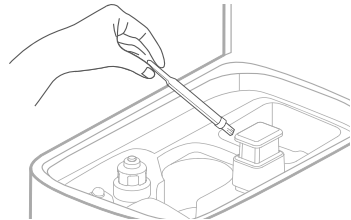

Figure 7.7

9. Rinse all parts until any vinegar smell is completely gone. [Figure 7.8]

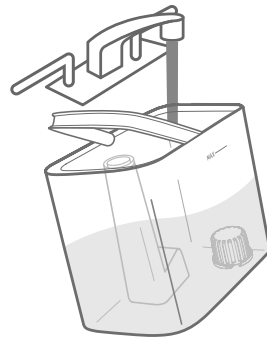

Figure 7.8

## Cleaning the Aroma Pad & Absorption Pad

1. Pull out the aroma box and remove the aroma pad. [Figure 8.1]

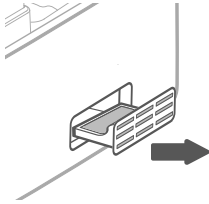

Figure 8.1

2. Remove the noise silencer, then remove the absorption pad from on top of the heating element. [Figure 8.2]

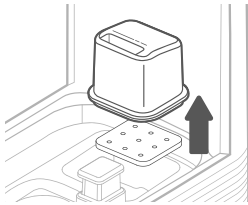

Figure 8.2

3. Rinse the pads under warm, running water. [Figure 8.3]

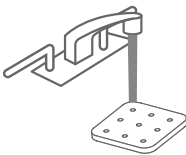

Figure 8.3

4. Dry the pads with a clean cloth.
5. Place the aroma pad back into the aroma box. [Figure 8.4]

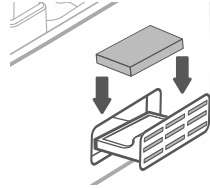

Figure 8.4

6. Place the absorption pad back into the base. [Figure 8.5]

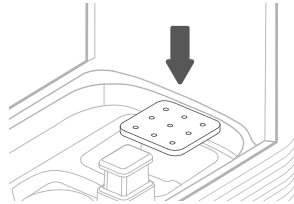

Figure 8.5

**Note: Do not** use liquid cleaners or detergents to clean the pads or any other part of the humidifier.

## Replacing the Aroma Pad & Absorption Pad

If the aroma pad or absorption pad is stiff even after cleaning, then it needs to be replaced. Extra pads are included with the humidifier.

To maintain the performance of your humidifier, **only** use official Levoit aroma pads and absorption pads. For more information, contact **Customer Support** (see page 26).

## Reassembling

1. Place the float back into the base chamber. *[Figure 9.1]*

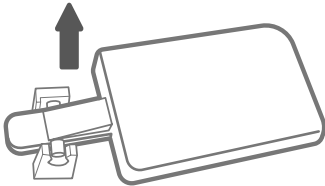

Figure 9.1

- a. Make sure the correct side of the float is facing up.
  - b. Insert the smaller prong into the closed side of the float brackets.
  - c. Place the larger prong into the open (U-shaped) side of the float brackets.
2. Place the absorption pad and the noise silencer back over the heating element. *[Figure 9.2]*

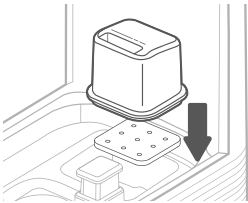

Figure 9.2

3. Flip the water tank over and replace the mist channel. *Figure 9.3]*

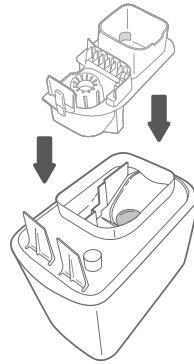

Figure 9.3

4. Make sure the water filter sponge is securely placed inside the water filter. Place the water filter back into the tank and rotate it clockwise to secure it in place. *[Figure 9.4]*

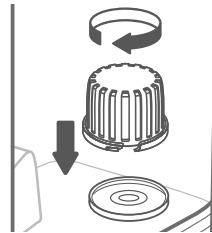

Figure 9.4

5. Refill the tank, if necessary. Place the tank properly on the base and place the tank cover on the water tank.

## Storing

Follow the cleaning instructions (see page 15) and allow all parts to dry completely before storing. Store in a cool, dry location.

# TROUBLESHOOTING

Problem	Possible Solution
Humidifier doesn't turn on, or turns off unexpectedly.	Plug the humidifier into a working outlet and turn it on.
	Add purified or distilled water to the water tank.
Little or no mist comes out.	Turn the mist level to a higher setting.
	Fill the water tank.
	There may be too much water in the base chamber. Empty the base chamber. Refill the water tank (not the base chamber) and place the water tank properly onto the base.
	Make sure the air inlets on the bottom of the base and in the aroma box are not blocked. The humidifier should not be set on carpet or other surfaces that may block the air inlets.
	Clean the humidifier (see <b>Care &amp; Maintenance</b> , page 15). Make sure the nozzles are not blocked or clogged.
	Make sure the humidifier is on a level surface.
	If the water tank or base was washed with detergent, rinse thoroughly with clean water to remove any detergent.
Humidifier uses water too quickly.	Clean the water filter (see page 17) or replace the water filter sponge with a new one. One replacement water filter sponge is included with this humidifier. For information on additional replacements, contact <b>Customer Support</b> (see page 26).
	The humidifier uses up water based on the environmental temperature and humidity. If your environment is cold and/or dry, the humidifier will run out of water faster.
Humidifier produces an unusual smell.	Using the warm mist function will use up water faster.
	If the humidifier is new, unplug and rinse all parts, then place in a cool, dry place for 12 hours.
	If essential oils were placed on the aroma pad, rinse the pad under clean water and allow it to dry.
	Clean the humidifier (see <b>Care &amp; Maintenance</b> , page 15).

## Troubleshooting (cont.)

Problem	Possible Solution
Humidifier makes a loud or unusual noise.	Make sure the water tank is properly in place (see <b>Getting Started</b> , page 8).
	Set mist level to a lower setting.
	Empty the base chamber. Refill the water tank (not the base chamber) and place the water tank properly onto the base.
	When using the warm mist function, the heating element may make a gurgling noise if the water level is low. Add more water to the water tank.
	The humidifier may be malfunctioning. Stop using the humidifier and contact <b>Customer Support</b> (see page 26).
Mist leaks from the base.	Make sure the water tank is properly in place (see <b>Getting Started</b> , page 8).
White dust appears around the humidifier.	We recommend using purified or distilled water to fill the humidifier. Avoid using water with high mineral content, such as tap water.
	Clean the humidifier (see <b>Care &amp; Maintenance</b> , page 15).
Water visibly leaks from the humidifier.	Avoid running the humidifier in a room with over 60% relative humidity.
	Wipe any excess water off the top and bottom of the base.
	<b>Do not</b> shake the humidifier.
	Make sure to place the humidifier on a flat, level surface.
	Check the water tank for leaks. If there are leaks, contact <b>Customer Support</b> (see page 26).
The area around the humidifier is damp or wet from condensation.	Humidity may be too high. Turn down the mist level, turn off the humidifier, or open a door or window to the room.
	Open a window to ensure proper airflow for the humidifier, or move the humidifier to a more well-ventilated room.
	Make sure the water tank is properly in place (see <b>Getting Started</b> , page 8).
	When replacing the water tank, wipe off excess water from the water tank and base.
Mist is not warm after pressing 	Allow the humidifier to heat up for about 15 minutes to produce warm mist.
	Clean the heating element (see <b>Care &amp; Maintenance</b> , page 15).
The mist is warm on the cool mist setting.	The heating element may still be warm after being used for warm mist. Allow the heating element to cool for at least 30 minutes.

## Troubleshooting (cont.)

Problem	Possible Solution
Mold grows inside the humidifier.	Clean the water tank and base chamber regularly (see <b>Care &amp; Maintenance</b> , page 15).
 lights up red.	Fill the water tank.
	Place the water tank properly on the base.
	Clean the water filter (see page 17) or replace it with a new one. To request a new water filter, contact <b>Customer Support</b> (see page 26).
Essential oil has little or no smell.	Add more essential oil. For best results, use pure essential oil.
Display shows an incorrect humidity percentage.	The room may be larger than the humidifier's effective range. Move to a room smaller than 215–430 ft <sup>2</sup> / 20–40 m <sup>2</sup> .
	Moisture may have built up inside the humidity sensor. Make sure the nozzles are facing away from the aroma box so that mist does not settle on the sensor inside the aroma box (see diagram in <b>Getting To Know Your Smart Humidifier</b> , page 8). Turn off the humidifier, remove the aroma box, and allow the sensor to air dry.
	If the humidifier is placed within 12 inches / 30 cm of a wall or in a corner, the humidity sensor cannot provide a proper reading for the relative humidity in the room.
	The humidity sensor will give an improper reading if it is exposed to dust. Avoid using the humidifier in dusty rooms. Avoid using tap water in the humidifier as this can increase dust in the air.
The humidity level isn't changing in my room.	Use a higher mist level setting.
	Depending on your environment, the humidifier may take longer to humidify your air.
	The room may be larger than the humidifier's effective range. If the room is larger than 215–430 ft <sup>2</sup> / 20–40 m <sup>2</sup> , the humidifier will not be as effective.
Display shows Error Code "E1", "E2".	The humidifier is malfunctioning. Contact <b>Customer Support</b> (see page 26).

If your problem is not listed, please contact **Customer Support** (see page 26).

# VESYNC APP TROUBLESHOOTING

## Why isn't my humidifier connecting to the VeSync app?

- Make sure your phone has Bluetooth® turned on and is not currently connected to another Bluetooth device.
- During the setup process, you must be on a secure 2.4GHz Wi-Fi network. Confirm that the network is working correctly.
- Make sure the Wi-Fi password you entered is correct.
- Make sure your humidifier and phone are within 30 ft / 10 m of each other.
- Reset the humidifier by pressing and holding  for 15 seconds. Then try connecting again.

## My humidifier is offline.

- Make sure the humidifier is plugged in. The humidifier may appear to be offline if it is unplugged, or if the outlet does not have power.
- Refresh the VeSync menu by swiping down on the screen.
- Make sure your router is connected to the internet and your phone's network connection is working.
- Reset the humidifier using one of these options:
  - a. Delete the humidifier from the VeSync app. Swipe left (iOS®) or press and hold (Android), then tap **Delete**. Then reconfigure your humidifier with the VeSync app.
  - b. Press and hold  for 15 seconds. Then reconfigure your humidifier with the VeSync app.

**Note:** Power outages, internet outages, or changing Wi-Fi routers may cause your humidifier to go offline.

## The VeSync app is displaying an incorrect humidity percentage while the humidifier is turned on.

- The room may be larger than the humidifier's effective range. Move to a room smaller than 215–430 ft<sup>2</sup> / 20–40 m<sup>2</sup>.
- Moisture may have built up inside the humidity sensor. Make sure the nozzles are facing away from the aroma box so that mist does not settle on the sensor inside the aroma box (see diagram in **Getting To Know Your Smart Humidifier**, page 8). Turn off the humidifier, remove the aroma box, and allow the sensor to air dry.
- If the humidifier is placed within 12 inches / 30 cm of a wall or in a corner, the humidity sensor cannot provide a proper reading for the relative humidity in the room.
- The humidity sensor will give an improper reading if it is exposed to dust. Avoid using the humidifier in dusty rooms.

**If your problem is not listed**, please contact **Customer Support** (see page 26).

## ATTRIBUTIONS

Apple App Store is a trademark of Apple Inc.

Google, Android, and Google Play are trademarks of Google LLC.

Wi-Fi® is a registered trademark of Wi-Fi Alliance®.

Amazon, Alexa and all related logos are trademarks of Amazon.com, Inc. or its affiliates.

iOS is a registered trademark of Cisco Systems, Inc. and/or its affiliates in the United States and certain other countries.

The Bluetooth® word mark and logos are registered trademarks owned by Bluetooth SIG, Inc. and any use of such marks by Arovast Corporation is under license. Other trademarks and trade names are those of their respective owners.

## FEDERAL COMMUNICATION COMMISSION INTERFERENCE STATEMENT - PART 15

This device complies with Part 15 of the FCC Rules. Operation is subject to the following two conditions:

- (1) This device may not cause harmful interference, and
- (2) This device must accept any interference received, including interference that may cause undesired operation.

NOTE: This equipment has been tested and found to comply with the limits for a Class B digital device, pursuant to Part 15 of the FCC Rules. These limits are designed to provide reasonable protection against harmful interference in a residential installation. This equipment generates, uses and can radiate radio frequency energy and, if not installed and used in accordance with the instructions, may cause harmful interference to radio communications. However, there is no guarantee that interference will not occur in a particular installation. If this equipment does cause harmful interference to radio or television reception, which can be determined by turning the equipment off and on, the user is encouraged to try to correct the interference by one or more of the following measures:

- Reorient or relocate the receiving antenna.
- Increase the separation between the equipment and receiver.
- Connect the equipment into an outlet on a circuit different from that to which the receiver is connected.
- Consult the dealer or an experienced radio/TV technician for help.

**FCC Caution:** Any changes or modifications not expressly approved by the party responsible for compliance could void the user's authority to operate this equipment.

### FCC Radiation Exposure Statement

This equipment complies with FCC radiation exposure limits set forth for an uncontrolled environment. End users must follow the specific operating instructions for satisfying RF exposure compliance. To maintain compliance with FCC RF exposure compliance requirements, please follow operation instructions as documented in this manual. This transmitter must not be co-located or operating in conjunction with any other antenna or transmitter. This equipment should be installed and operated with a minimum distance of 20 cm between the radiator and your body. The availability of some specific channels and/or operational frequency bands are country dependent and are firmware programmed at the factory to match the intended destination. The firmware setting is not accessible by the end user.

## FEDERAL COMMUNICATION COMMISSION INTERFERENCE STATEMENT - PART 18

This device complies with part 18 of the FCC Rules.

This equipment generates and uses ISM frequency energy and if not installed and used properly, that is in strict accordance with the manufacturer's instructions, may cause interference to radio and television reception. It has been type tested and found to comply with limits for an ISM Equipment pursuant to part 18 of FCC Rules, which are designed to provide reasonable protection against such interference in a residential installation. However, there is no guarantee that interference will not occur in a particular installation. If this equipment does cause interference to radio or television reception, which can be determined by tuning the equipment off and on, the user is encouraged to try to correct the interference by one or more of the following:

- Reorient the receiving antenna of radio or television.
- Relocate the equipment with respect to the receiver.
- Move the equipment away from the receiver.
- Plug the equipment into a different outlet so that the equipment and receiver are on different branch circuits.

Conduct only the user maintenance found in this manual. Other maintenance and servicing can cause harmful interference and can void the required FCC compliance. The manufacturer is not responsible for any radio or TV interference caused by unauthorized modification to the equipment. It is the responsibility of the user to correct such interference.

## FCC SDOC SUPPLIER'S DECLARATION OF CONFORMITY

Arovast Corporation hereby declares that this equipment is in compliance with the FCC Part 18 Subpart B. The declaration of conformity may be consulted in the support section of our website, accessible from [www.levioit.com](http://www.levioit.com)



# WARRANTY INFORMATION

<b>Product</b>	OasisMist™ Smart Humidifier
<b>Model</b>	LUH-O451S-WUS
<i>For your own reference, we strongly recommend that you record your order ID and date of purchase.</i>	
<b>Order ID</b>	
<b>Date of Purchase</b>	

## Terms & Policy

Arovast Corporation (“Arovast”) warrants this product to the original purchaser to be free from defects in material and workmanship, under normal use and conditions, for a period of 2 years from the date of original purchase.

Arovast agrees, at our option during the warranty period, to repair any defect in material or workmanship or furnish an equal product in exchange without charge, subject to verification of the defect or malfunction and proof of the date of purchase.

There is no other express warranty. This warranty does not apply:

- If the product has been modified from its original condition;
- If the product has not been used in accordance with directions and instructions in the user manual;
- To damages or defects caused by accident, abuse, misuse or improper or inadequate maintenance;
- To damages or defects caused by service or repair of the product performed by an unauthorized service provider or by anyone other than Arovast;
- To damages or defects occurring during commercial use, rental use, or any use for which the product is not intended;
- To damages or defects exceeding the cost of the product.

Arovast will not be liable for indirect, incidental, or consequential damages in connection with the use of the product covered by this warranty.

This warranty extends only to the original consumer purchaser of the product and is not transferable to any subsequent owner of the product regardless of whether the product is transferred during the specified term of the warranty.

This warranty does not extend to products purchased from unauthorized sellers. Arovast’s warranty extends only to products purchased from authorized sellers that are subject to Arovast’s quality controls and have agreed to follow its quality controls.

All implied warranties are limited to the period of this limited warranty.

This warranty gives you specific legal rights and you may also have other rights which vary from state to state. Some states do not allow the exclusion or limitation of incidental or consequential damages, so the above limitation or exclusion may not apply to you.

If you discover that your product is defective within the specified warranty period, please contact Customer Support via [support@levoit.com](mailto:support@levoit.com). **DO NOT** dispose of your product before contacting us. Once our Customer Support Team has approved your request, please return the product with a copy of the invoice and order ID.

Every Levoit product automatically includes a 2-year warranty. To make the customer support process quick and easy, register your product online at [www.levoit.com/warranty](http://www.levoit.com/warranty).

This warranty is made by:

Arovast Corporation  
1202 N. Miller St., Suite A  
Anaheim, CA 92806

# CUSTOMER SUPPORT

If you have any questions or concerns about your new product, please contact our helpful Customer Support Team.

## **Arovast Corporation**

1202 N. Miller St., Suite A  
Anaheim, CA 92806

**Email:** [support@levoit.com](mailto:support@levoit.com)

**Toll-Free:** (888) 726-8520

## **Support Hours**

Mon–Fri, 9:00 am–5:00 pm PST/PDT

\*Please have your order invoice and order ID ready before contacting Customer Support.



**lěvoit<sup>®</sup>**



/LEVOITLIFESTYLE



/LEVOIT



/LEVOIT



/LEVOIT



LEVOIT.COM