

levoit

USER MANUAL

Ultrasonic Cool Mist Humidifier

Model: Classic 200

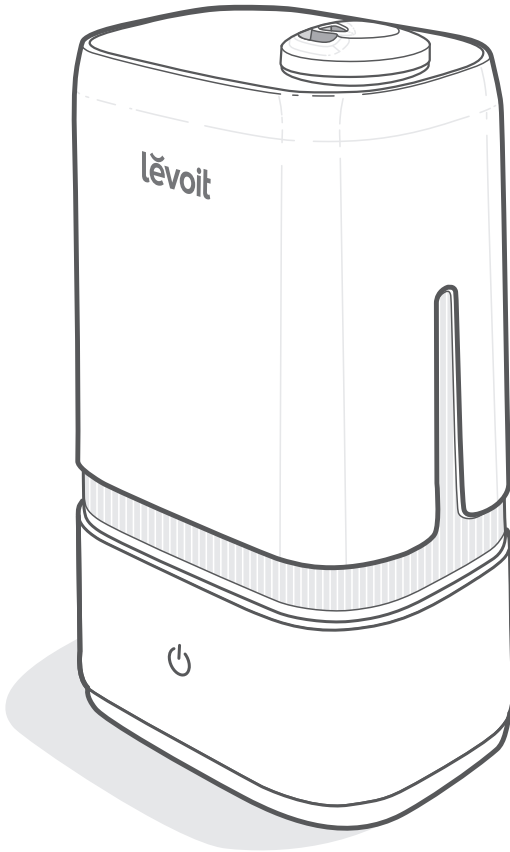

Questions or Concerns?

Please contact us Mon–Fri, 9:00 am–5:00 pm PST/PDT at support@levoit.com or at **(888) 726-8520**.

Thank you for purchasing the
**ULTRASONIC COOL
MIST HUMIDIFIER
BY LEVOIT.**

If you have any questions or concerns, please reach out to us at support@levoit.com. We hope you enjoy your new humidifier!

Find Us Online

Search for [@LevoitLifestyle](#) • [#LevoitLove](#) • [#LevoitLifestyle](#) on social media for tips, special deals, giveaways, inspiration, and more.

Table of Contents

Package Contents	3
Specifications	3
Safety Information	4
• General Safety	4
• Plug & Cord	5
Getting to Know Your Humidifier	6
Getting Started	7
• Filling & Refilling	8
Using Your Humidifier	10
• Important Tips	11
• Using the Aroma Box	12
• Preventing Leaks	12
Care & Maintenance	13
• Cleaning	13
• Cleaning the Aroma Pad	16
• Reassembling	17
• Storing	17
Troubleshooting	18
Warranty Information	20
Customer Support	21

Package Contents

1 x	Ultrasonic Humidifier
3 x	Aroma Pads (1 Pre-Installed)
1 x	Cleaning Brush
1 x	User Manual
1 x	Quick Start Guide

Specifications

Power Supply	AC 120V, 60Hz
Rated Power	30W
Water Tank Capacity	1.05 gal / 4 L
Max Run Time	Up to 40 hours on low mist setting Note: <i>The humidifier will be able to run for a longer or shorter time depending on the environmental temperature and humidity.</i>
Noise Level	≤ 30dB
Effective Range	285–376 ft ² / 24–35 m ²
Dimensions	14 x 8 x 6 in / 35.4 x 20.2 x 15.2 cm
Weight	3.5 lb / 1.6 kg

SAFETY INFORMATION

To reduce the risk of fire, electric shock, or other injury, follow all instructions and safety guidelines.

General Safety

- **Only** use the humidifier as described in this manual.
- Place the humidifier and cord so that it will not be knocked over. **Do not** place near large pieces of furniture or in high-traffic areas.
- When not in use, turn the humidifier off and disconnect from power by removing the plug from the outlet.
- **Do not** use the humidifier in wet environments.
- Keep the humidifier out of reach from children.
- **Do not** open the base or remove the water level sensor for self-servicing.
- **Always** unplug your humidifier from the power outlet before cleaning your humidifier or detaching the water tank from the humidifier base.
- **Always** make sure to place the humidifier on a flat, level surface before operation.
- **Only** fill the water tank with clean water. **Never** fill the water tank with any other liquids.
- **Do not** place the humidifier near sources of heat, such as stovetops, ovens, or radiators.
- **Do not** place the humidifier directly on floors, carpets, or rugs.
- **Do not** use other items as replacement parts for this product.
- **Do not** cover the nozzles while the humidifier is on. Doing so may damage the humidifier.
- Remove the water tank from the base before moving the humidifier.
- **Do not** immerse the humidifier base, power cord, or plug in water.
- If the humidifier is damaged or is not functioning properly, stop using it and contact **Customer Support** immediately (see page 21).
- Not for commercial use. Household use **only**.

Caution: Risk of Leaks and Electric Shock

- **Do not** add essential oils, supplemental water treatment liquids, or water filters into the water tank or base chamber. This will damage the humidifier and cause leaks. **Only** add essential oils to the aroma pad.

SAFETY INFORMATION (CONT.)

Plug & Cord

- Ensure that the plug fits properly into a polarized socket.
- **Do not** handle the power cord or plug with wet hands. Keep the plug and power cord away from liquids.
- Your humidifier has a polarized plug (one prong is wider than the other), which fits into a polarized outlet only one way. This is a safety feature to reduce the risk of electric shock. If the plug does not fit, reverse the plug. If it still does not fit, **do not** use the plug in that outlet. **Do not** bypass this safety feature.

**READ AND SAVE THESE
INSTRUCTIONS**

GETTING TO KNOW YOUR HUMIDIFIER

- A. Nozzles
- B. Nozzle Cover
- C. Water Tank Handle
- D. Mist Outlet
- E. Water Tank
- F. Cleaning Brush
- G. Cleaning Brush Storage
- H. Base
- I. Control Button
- J. Insulation Ring
- K. Transducer
- L. Float Housing
- M. Float
- N. Mist Tube
- O. Water Tank Windows
- P. Air Outlet
- Q. Base Chamber
- R. Power Cord
- S. Water Tank Cap
- T. Silicone Sealing Ring
- U. Water Valve
- V. Noise Silencer
- W. Aroma Pad
- X. Aroma Box
- Y. Air Inlet

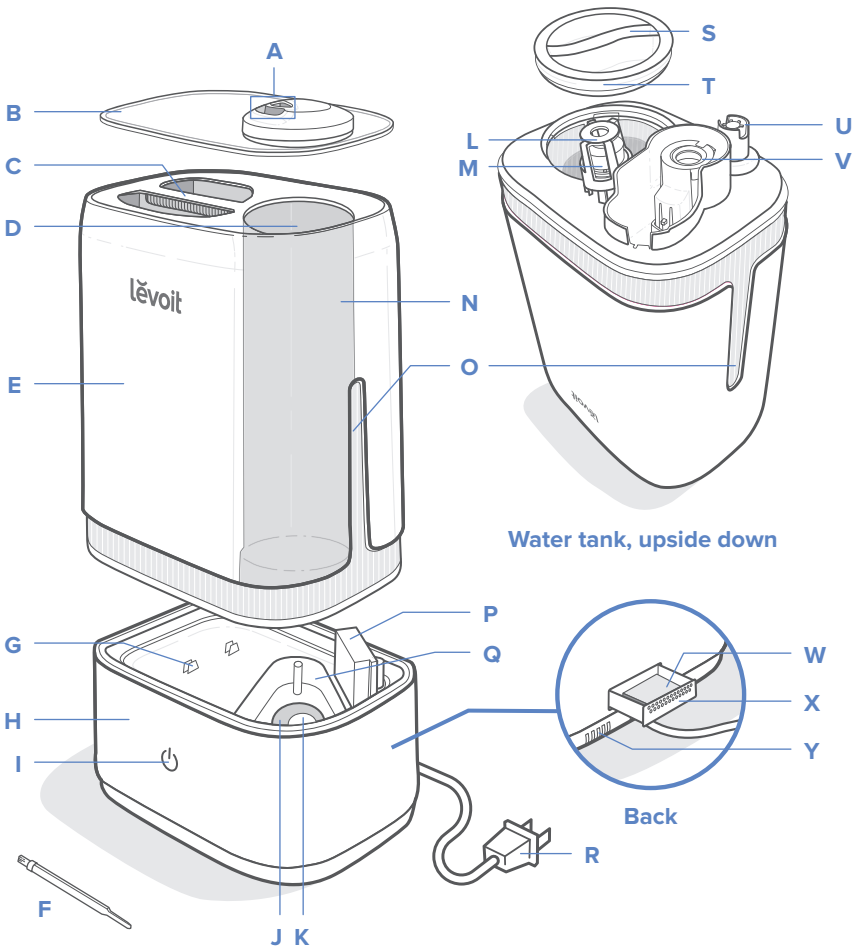

Water tank, upside down

Back

GETTING STARTED

1. Remove all packaging.
2. Choose a hard, flat location for the humidifier at least 12 in / 30 cm away from any walls. The surface must be water-resistant. *[Figure 1.1]*

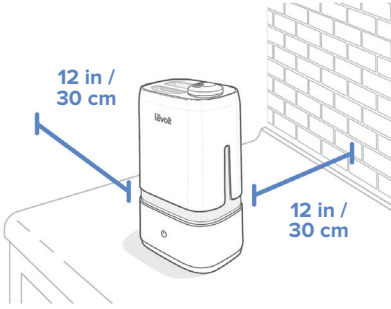

Figure 1.1

3. Mist should be directed away from walls, furniture, bedding, and appliances. *[Figure 1.2]*

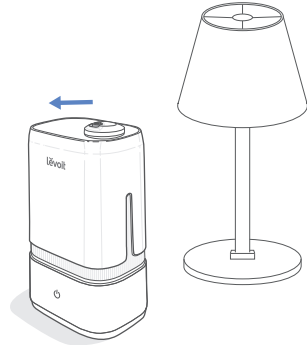

Figure 1.2

Filling & Refilling

1. Remove the nozzle cover from the water tank. Use the handle to lift the water tank from the base. *[Figure 1.3]*

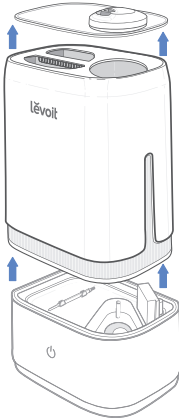

Figure 1.3

2. Flip over the water tank and remove the water tank cap by twisting it counterclockwise. *[Figure 1.4]*

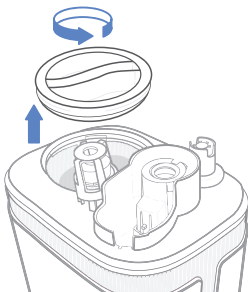

Figure 1.4

3. Fill the tank with room-temperature water. *[Figure 1.5]* **Do not** fill with hot water.

Note: We recommend using purified or distilled water to fill the tank.

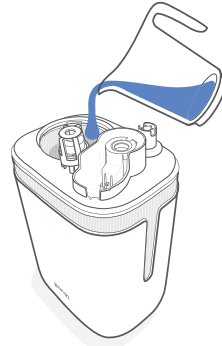

Figure 1.5

Filling & Refilling (cont.)

CAUTION

- **Do not** add water directly into the base chamber. [Figure 1.6]

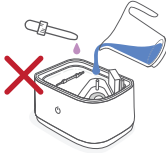

Figure 1.6

- **Do not** add water through the mist tube.
- **Do not** add essential oils into the humidifier. [Figure 1.7] **Only** add essential oils to the aroma pad. [Figure 1.8]



Figure 1.7

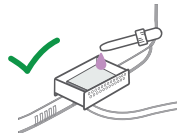

Figure 1.8

- **Do not** use water treatment liquids, or third-party water filters in this humidifier.

4. Replace the water tank cap and align the arrow with the lock. [Figure 1.9]

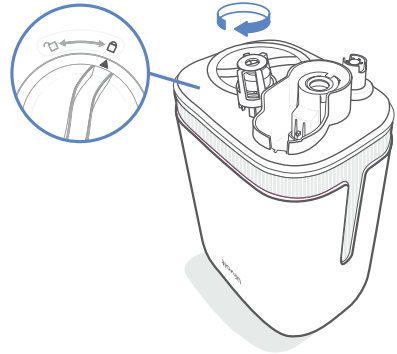

Figure 1.9

5. Place the tank back on the base and replace the nozzle cover onto the water tank. [Figure 1.10]

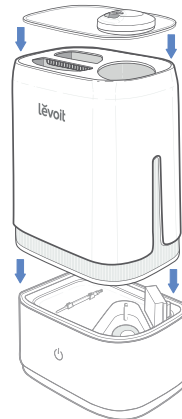



Figure 1.10

USING YOUR HUMIDIFIER

1. Plug in the humidifier.
2. Tap  to turn your humidifier on. Tap repeatedly to change the mist setting. *[Figure 2.1]*

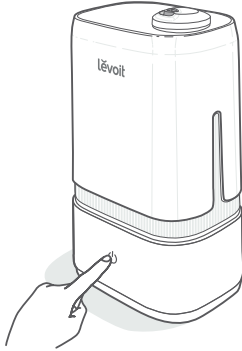

Figure 2.1

3. Rotate the nozzles to adjust the direction of the mist. *[Figure 2.2]*

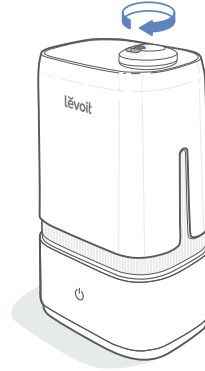



Figure 2.2

Control Button Color

Button Color	Function
Blue	Low mist setting is selected
Orange	Medium mist setting is selected
Purple	High mist setting is selected
Red	No water in tank or tank not on base
Off	Humidifier is off
	Button light has been turned off

Note: Press and hold  for 3 seconds to turn off the button light.

4. When your room has reached a comfortable humidity level, turn your humidifier to a lower setting or turn it off. A comfortable humidity level is above 40% and below 60%. *[Figure 2.3]*

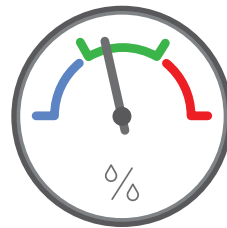



Figure 2.3

Note:

- Low mist is the default setting when the humidifier is first turned on.
- If there is no water in the tank or the tank is removed, the humidifier will stop misting, the fan will turn off after 5 seconds, and  will turn red.

Important Tips

Your humidifier must have the correct level of water in the base chamber to work properly. If there is too much water in the base chamber, the humidifier cannot create mist.

- **Never** pour water directly into the base chamber. **Only** add water to the water tank. [Figure 2.4] The humidifier will automatically release the correct amount of water into the base chamber.
- Avoid moving or shaking the humidifier. [Figure 2.5] This may cause the water tank to release too much water into the base chamber.
- Before moving the humidifier, turn it off, unplug it, and remove the water tank.
- If your humidifier doesn't produce mist correctly, check the max water line to see if there is too much water in the base chamber. Pour out extra water if water is over the max line. [Figure 2.6]

Note: The max water line is **only** for this purpose. **Do not pour water into the base chamber.**

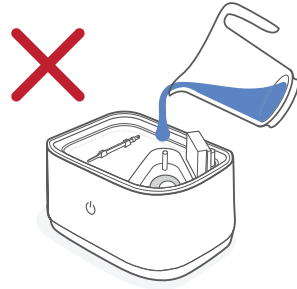

Figure 2.4

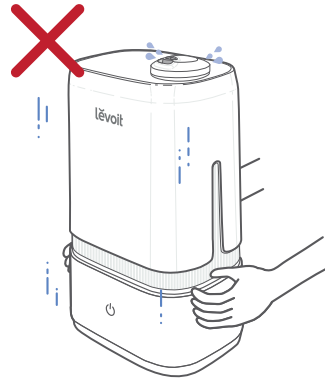

Figure 2.5

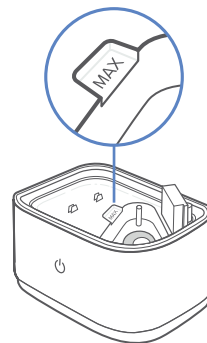

Figure 2.6

Using the Aroma Box

Your humidifier can be used as an aroma diffuser.

1. Push the aroma box at the back of the base and pull it out. [Figure 2.7]

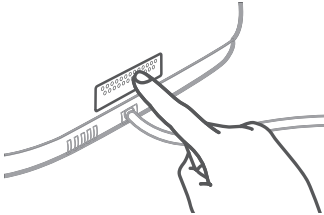

Figure 2.7

2. Put 2–3 drops of essential oil on the aroma pad. [Figure 2.8]

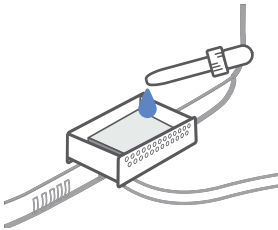

Figure 2.8

3. Place the aroma box into the humidifier. The humidifier will automatically diffuse aroma when used.

Note:

- **Do not** add essential oils, water treatment liquids, or third-party water filters into the water tank or base chamber. **Only** add essential oils to the aroma pad.
- The aroma pads can be cleaned and reused after diffusing essential oils (see **Cleaning the Aroma Pad**, page 16).

Preventing Leaks

The water tank may leak if not placed properly.

- Make sure the silicone sealing ring around the water tank cap is secured at all times.
- Twist and secure the cap tightly onto the water tank. Make sure the arrow is aligned with the lock. [Figure 2.9]

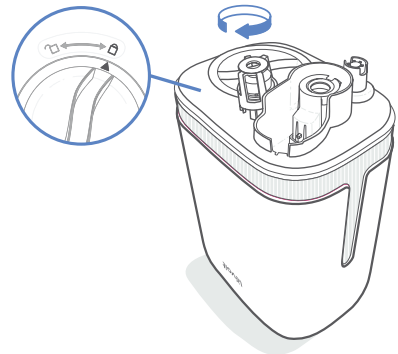

Figure 2.9

Note: A small gap between the cap and the tank is normal.

- Wipe any excess water off the top and bottom of the base.
- **Do not** shake the humidifier.
- Make sure to place the humidifier on a flat, level surface.

CARE & MAINTENANCE

Note:

- All maintenance should be done on a water-resistant surface, such as a kitchen counter.
- Change the water daily to avoid bacteria growth.
- Use a tissue or cloth to clean the nozzles regularly.
- If not using the humidifier for 1 week or longer, **do not** leave water inside. Clean and dry the humidifier instead.

Cleaning

You should clean your humidifier every week, and when you're ready to store it.

Note:

- **Never** immerse the base in water or liquid. **Do not** place any part of the humidifier in a dishwasher.
 - **Do not** use detergents to clean the humidifier.
1. Unplug the humidifier.
 2. Remove and rinse the nozzle cover. [Figure 3.1]

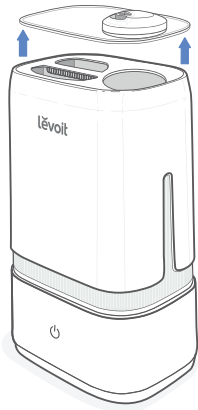

Figure 3.1

3. Remove the water tank from the base. Pour out any water from the tank and base chamber. [Figure 3.2]

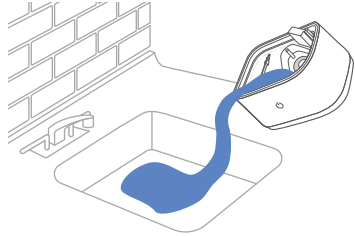

Figure 3.2

4. Rinse the tank and base chamber with room temperature water. [Figure 3.3]

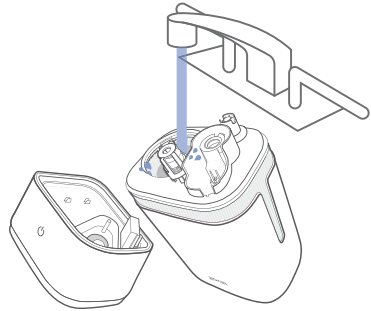

Figure 3.3

Cleaning (cont.)

5. To descale the humidifier:

- a. Fill the tank with 3 US cups / 710 mL of distilled white vinegar. *[Figure 3.4]*

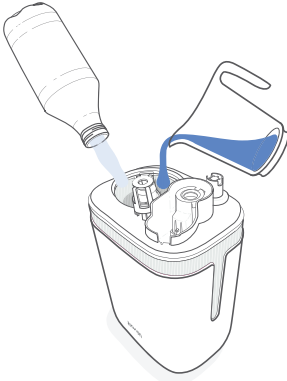

Figure 3.4

- b. Replace the tank cap and swish the vinegar around the tank. *[Figure 3.5]*

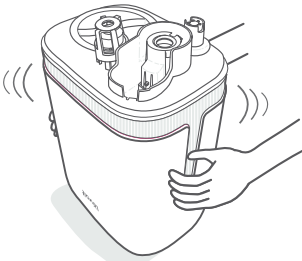

Figure 3.5

- c. Place the tank on the base and soak for 15–20 minutes. Vinegar will drain into the base chamber and loosen scale (mineral buildup) in the tank and in the base chamber (including the transducer and float). *[Figure 3.6]*

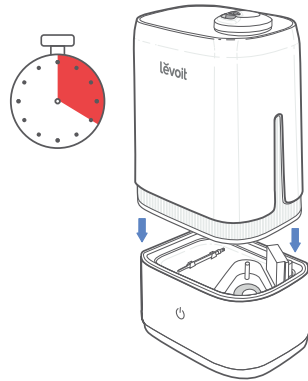

Figure 3.6

- d. Remove the tank and pour out any vinegar. *[Figure 3.7]*

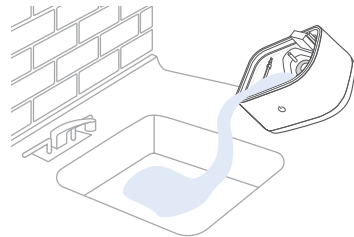

Figure 3.7

Cleaning (cont.)

- e. Flip the tank over and remove the tank cap and noise silencer. To remove the noise silencer, press the release tab and gently pull away from the humidifier.

[Figure 3.8]

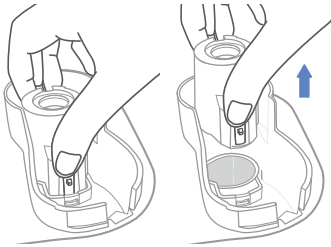

Figure 3.8

- f. Place the tank cap and noise silencer in a small container and fill with enough vinegar to cover them. Soak for 15–20 minutes.

[Figure 3.9]

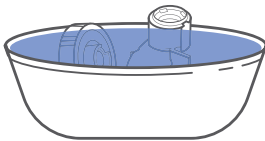

Figure 3.9

- g. Use a soft cloth and the included cleaning brush to remove scale.

[Figure 3.10]

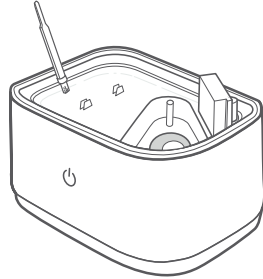

Figure 3.10

- h. Rinse all parts until any vinegar smell is completely gone.

[Figure 3.11]

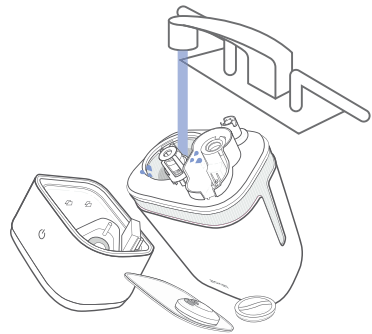

Figure 3.11

- 6. Dry all parts with a cloth. Make sure all parts are completely dry before reassembling or storing.

Note: Brush can be stored in the brush storage slots in the base.

Cleaning the Aroma Pad

1. Press the aroma box to release it from the base, and pull it out. *[Figure 3.12]*

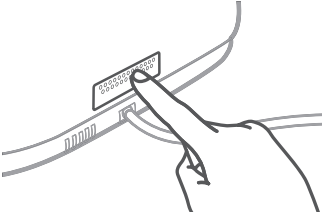

Figure 3.12

3. Dry with a clean cloth and place it back into the aroma box. *[Figure 3.14]*

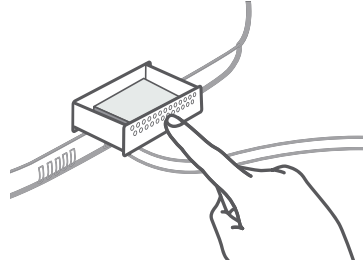

Figure 3.14

2. Remove the aroma pad and rinse under warm, running water. *[Figure 3.13]*

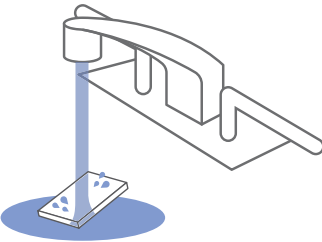

Figure 3.13

Note: Do not pour liquid cleaners or detergents into the aroma pad or box.

Reassembling

1. Flip the water tank over and replace the noise silencer on the tank. *[Figure 3.15]*

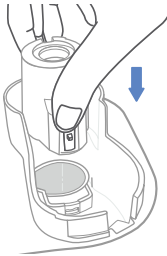

Figure 3.15

2. Refill the tank, if necessary. Replace the water tank cap by firmly twisting it back in place, aligning the arrow with the lock. *[Figure 3.16]*

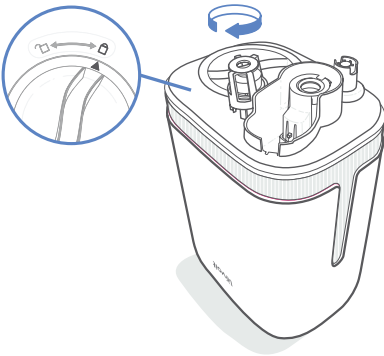

Figure 3.16

3. Store the brush in the brush storage slots in the base. *[Figure 3.17]*

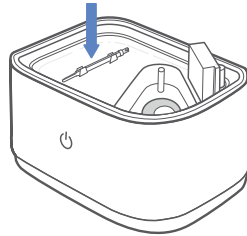

Figure 3.17

4. Place the tank properly on the base and replace the nozzle cover onto the water tank. *[Figure 3.18]*

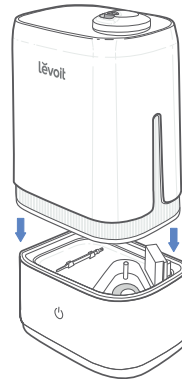

Figure 3.18

Storing

Follow the cleaning instructions (see page 13) and allow all parts to dry completely before storing. Store in a cool, dry location.

TROUBLESHOOTING

Problem	Possible Solution
Humidifier doesn't turn on.	Plug in the humidifier and turn it on.
	Add purified or distilled water to the water tank.
Little or no mist comes out.	Turn the mist level to a higher setting.
	Fill the water tank.
	There may be too much water in the base chamber. Empty the base chamber. Refill the water tank (not the base chamber) and place the water tank properly onto the base.
	Make sure the air inlet on the bottom of the base is not blocked. The humidifier should not be set on carpet or other surfaces that may block the air inlet.
	Make sure the nozzles are not blocked or clogged.
	Make sure the humidifier is on a level surface.
	The water temperature may be too low. Turn the mist level to the highest setting and let the humidifier run for a while, then adjust to the desired setting.
	If the water tank or base was washed with detergent, rinse thoroughly with clean water to remove any detergent.
Humidifier uses water too quickly.	The humidifier uses up water based on the environmental temperature and humidity. If your environment is cold and/or dry, the humidifier will run out of water faster.
Humidifier produces an unusual smell.	If the humidifier is new, remove and rinse the water tank cap, and place the water tank in a cool, dry place for 12 hours.
	If essential oils were placed on the aroma pad, rinse the pad under clean water, and allow it to dry.
	Clean the water tank and base chamber (see Care & Maintenance , page 13).

TROUBLESHOOTING (CONT.)

Problem	Possible Solution
Humidifier makes a loud or unusual noise.	Make sure the water tank is properly in place (see Getting Started , page 7).
	Set mist level to a lower setting.
	The humidifier may be malfunctioning. Stop using the humidifier and contact Customer Support (see page 21).
	Empty the base chamber. Refill the water tank (not the base chamber) and place the water tank properly onto the base.
White dust appears around the humidifier.	We recommend using purified or distilled water to fill the humidifier. Avoid using water with high mineral content.
	Clean the humidifier (see Care & Maintenance , page 13).
Water leaks from the humidifier.	Make sure the silicone sealing ring around the water tank cap is secure and tighten the water tank cap.
Condensation forms around humidifier or windows.	Humidity may be too high. Turn down the mist level, turn off the humidifier, or open a door or window to the room.
Mold grows inside the humidifier.	Clean the water tank and inner chamber regularly (see Care & Maintenance , page 13).
 is red.	Fill the water tank.
	Place the water tank properly on the base.
Essential oils have little or no smell.	Add more essential oils. For best results, use pure essential oils.

If your problem is not listed, please contact **Customer Support** (see page 21).

WARRANTY INFORMATION

Product	Ultrasonic Cool Mist Humidifier
Model	Classic 200
Default Warranty Period	1 year
<i>For your own reference, we strongly recommend that you record your order ID and date of purchase.</i>	
Date of Purchase	
Order ID	

Terms & Policy

Arovast Corporation warrants all products to be of the highest quality in material, craftsmanship, and service, effective from the date of purchase to the end of the warranty period.

Arovast Corporation will replace any product found to be defective due to manufacturer flaws based on eligibility. Refunds are available within the first 30 days of purchase. Refunds are only available to the original purchaser of the product. This warranty extends only to personal use and does not extend to any product that has been used for commercial, rental, or any other use for which the product is not intended. There are no warranties other than the warranties expressly set forth with each product.

This warranty is non-transferrable. Arovast Corporation is not responsible in any way for any damages, losses, or inconveniences caused by equipment failure by user negligence, abuse, or use noncompliant with the user manual or any additional safety, use, or warnings included in the product packaging and manual.

This warranty does not apply to the following:

- Damage due to abuse, accident, alteration, misuse, tampering, or vandalism.
- Improper or inadequate maintenance.
- Damage in return transit.
- Unsupervised use by children under 18 years of age.

Arovast Corporation and its subsidiaries assume no liability for damage caused by the use of the product other than for its intended use or as instructed in the user manual. Some states do not allow this exclusion or limitation of incidental or consequential losses so the foregoing disclaimer may not apply to you. This warranty gives you specific legal rights and you may also have other rights which may vary from state to state.

ALL EXPRESSED AND IMPLIED WARRANTIES, INCLUDING THE WARRANTY OF MERCHANTABILITY, ARE LIMITED TO THE PERIOD OF THE LIMITED WARRANTY.

Extend Your Warranty by 1 Year

Register your product at www.levoit.com/warranty to extend your 1-year warranty by an additional year.

Please fill out all required fields and include your order ID, place of purchase, and purchase date, if applicable.

Defective Products & Returns

If your product proves defective within the specified warranty period, please contact Customer Support via support@levoit.com with your order ID. **Do not** dispose of your product before contacting us. Once Customer Support has approved your request, please return the unit with a copy of the invoice or your order ID.

CUSTOMER SUPPORT

If you encounter any issues or have any questions regarding your new product, feel free to contact our helpful Customer Support Team.

Arovast Corporation

1202 N. Miller St., Suite A
Anaheim, CA 92806

Email: support@levoit.com

Toll-Free: (888) 726-8520

Support Hours

Mon–Fri, 9:00 am–5:00 pm PST/PDT

*Please have your order invoice and order ID ready before contacting Customer Support.

Connect with us @LevoitLifestyle



lěvoit

levoit.com